

IP67

# ALDEBARAN® XLD SERIES DESIGNED FOR 24/7 USE UNDER THE TOUGHEST CONDITIONS



**LIGHTING ALSO WITH WET & DUSTY  
CONDITIONS OF USE**

**IP67**

Video / Endurance test



[y2u.be/wq-03qelClo](https://www.youtube.com/watch?v=y2u.be/wq-03qelClo)





## **GENERAL FACTS ABOUT THE ALDEBARAN® XLD SERIES**

- + High IP code (up to IP67\*), dust- and water-proof
- + Resistant to almost all environmental influences
- + Shock- and vibration-proof
- + Glare-free
- + Easy to clean
- + Reparability
- + High energy efficiency

\*Models without switch box



**ALDEBARAN® XLD  
TECHNOLOGY FOR EFFICIENT  
LIGHT GENERATION**





## ALDEBARAN® XLD-2C PRODUCT CHARACTERISTICS

- ✔ IP67\*, dust- & water-proof
- ✔ Light power with 90.000 REAL Lumen
- ✔ 8 x SETO Xpect2 LED module
- ✔ Slip-on filters for homogeneous illumination in close range
- ✔ High energy efficiency:  
560 W power consumption - 90.000 REAL Lumen: 160 Lm/W (output)

### **PRODUCT VARIATIONS:**

**XLD-2C BASIC:** (supply line)

**XLD-2C SWITCH:** (supply line + switch box)

**XLD-2C DIM:** (supply line + switch box incl. dimming function)

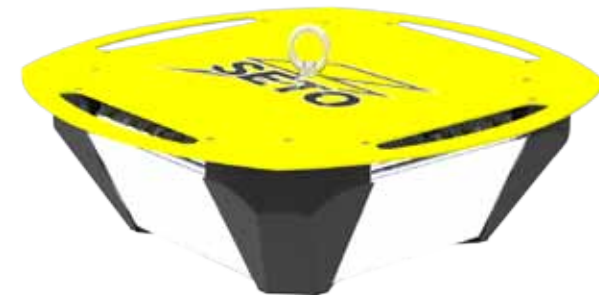



\*Models without switch box

# DIE ALDEBARAN® XLD-2C PRODUCT VARIANTS

„The products of the **XLD-C SERIES** are characterized by the lowest maintenance costs and high reparability. **Particularly in the harsh environment of construction sites, the special features such as fast-replaceable connection cables, cable strain relief and the highest line quality are indispensable advantages.**

Combined with the endurance, robustness and performance of all XLD products, this results in the ultimate lighting tool for the applications“

**NOTE:** All connection cables are exchangeable and available as spare parts.

REPLACEMENT / ACCESSORIES		ITEM NO.:
	Supply line	1410001510
	Supply line with switch box	1410001520
	Supply line with switch box + Dimmer	1410001521

## XLD-2C BASIC

### SUPPLY LINE

- 01 With connector
- 02 Cable with plug IP68

Item no.: 1410001502

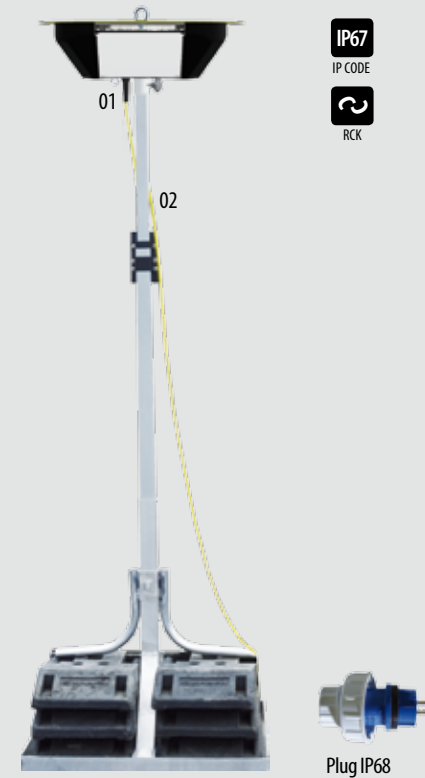

RCK:  
REPLACEABLE CABLE-SET



## XLD-2C SWITCH

### SUPPLY LINE + SWITCH BOX

- 01 With connector
- 02 Cable with plug IP68
- 03 Switch box IP65 pressure switch, segmental switching (180°) possible

Item no.: 1410001503

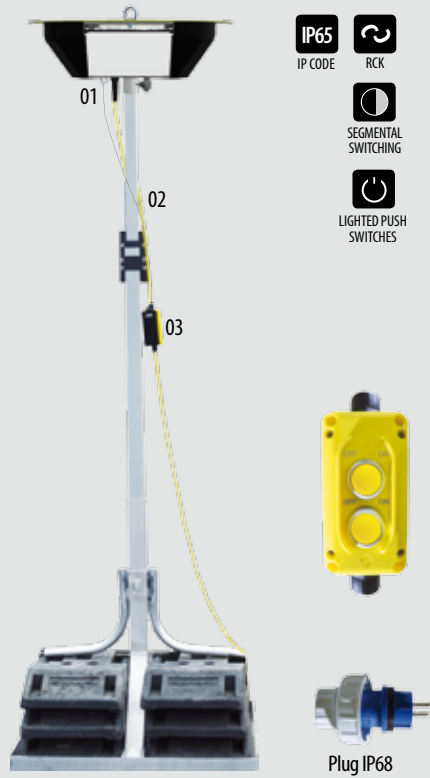

## XLD-2C DIM

### SUPPLY LINE + SWITCH BOX + DIMMING FUNCTION

- 01 With connector
- 02 Cable with plug IP68
- 03 Switch box IP65 pressure switch + Dimmer switch, segmental switching (180°) possible

Item no.: 1410001504

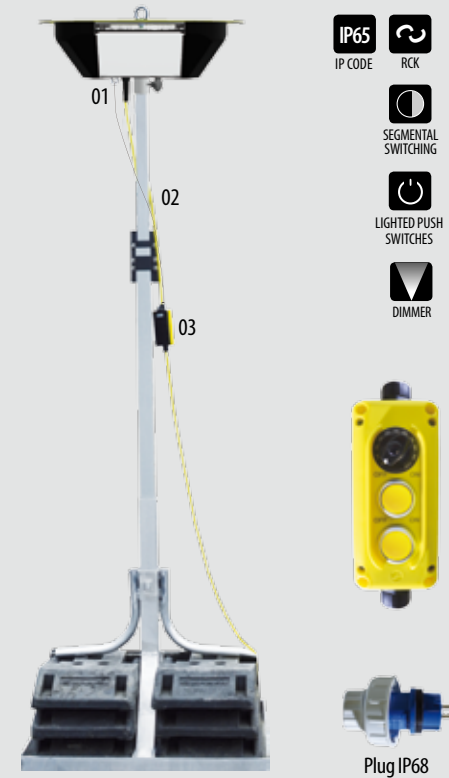

# ALDEBARAN® XLD SERIES LATEST LIGHT TECHNOLOGY

01

02

03

05





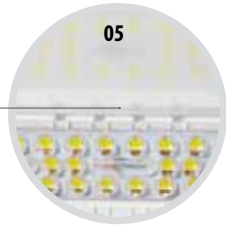
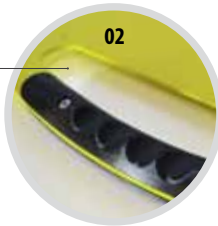
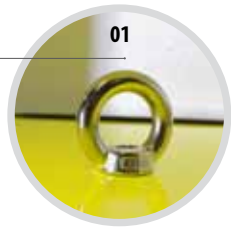

- 01**  
+ **MOUNTING RING**  
suspension of the all around luminaire
  
- 02**  
+ **ERGONOMIC CARRYING HANDLE**  
installed robust carrying handle in black for easy transportation
  
- 03**  
+ **HIGH POWER LED MODULE**  
SETO XPECT2 MODULE with multi-lens technology
  
- 04**  
+ **INPUT LINE (H07BQ-F 3G1,5 / Length: 8 m)**  
robust and resistant sharp edges,  
with plug IP68
  
- 05**  
+ **INTEGRATED DIFFUSERS**  
for homogeneous illumination in close range
  
- 06**  
+ **MAST BOLT**  
integrated bolt reception with star knob for fast and  
tool-free mast mounting  
*(other receptions possible)*

**ALDEBARAN® XLD-2C  
INTELLIGENT EQUIPMENT**

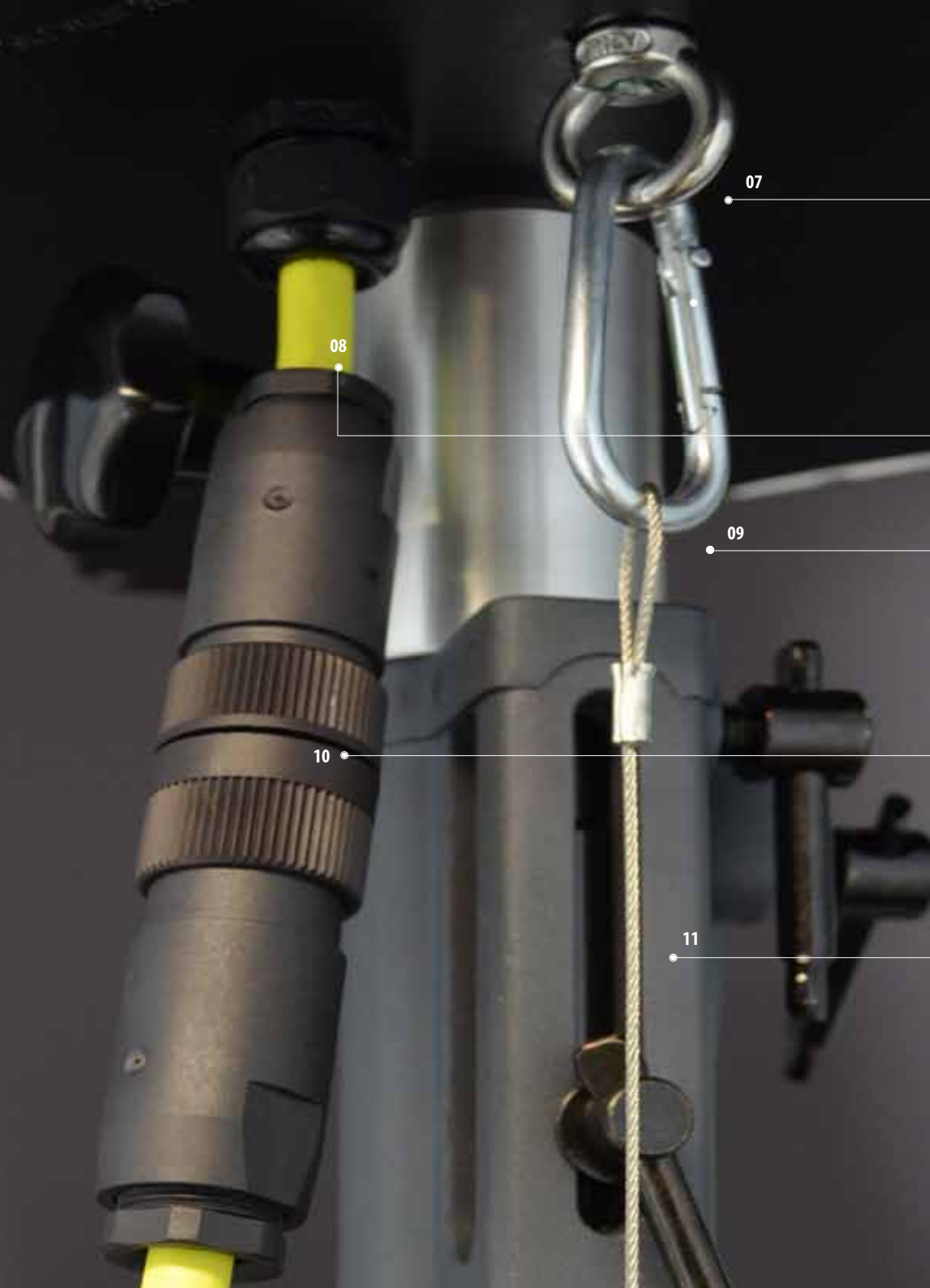

07

08

09

10

11

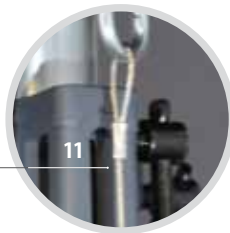
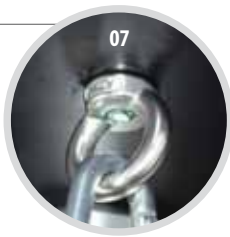

**07**  
+ **METAL EYELET**  
a durable metal ring for fastening

**08**  
+ **ÖLFLEX® 540P**  
robust line, oil resistant and flexible for versatile use

**09**  
+ **SNAP HOOK**  
made of stainless steel with spring-assisted snap closure for quick attachment to eyelets and loops

**10**  
+ **CONNECTOR**  
water-proof connector, protects the electrical interface from extreme weather conditions like dirt, dust and moisture

**11**  
+ **STEEL ROPE**  
robust steel wire rope with loop, weather resistant and with high breaking force



# ALDEBARAN® XLD-2C OPERATING UNITS

+ **XLD-2C SWITCH**  
**INPUT LINE WITH SWITCH BOX (IP65)**  
with edge protection pressure switch „ON / OFF“

or

+ **XLD-2C DIM**  
**INPUT LINE WITH SWITCH BOX + DIMMING FUNCTION (IP65)**  
with edge protection pressure switch „ON / OFF“ and integrated dimming  
switch for stepless regulation of the luminous flux

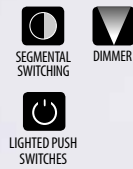

- + **PUR CABLE**  
cutting, abrasion and notched cable for rough continuous operations, e.g. in the construction site area
- + **PLUG (IP68)**  
protected against water, dust and dirt, with stands extreme temperatures

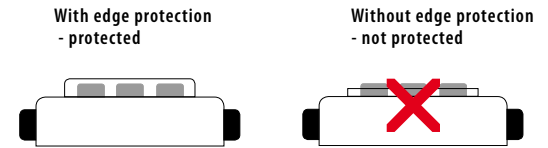

- + **EDGE PROTECTION PROTECTS SWITCH ELEMENTS**  
from dirt, and breaking off of single push switches

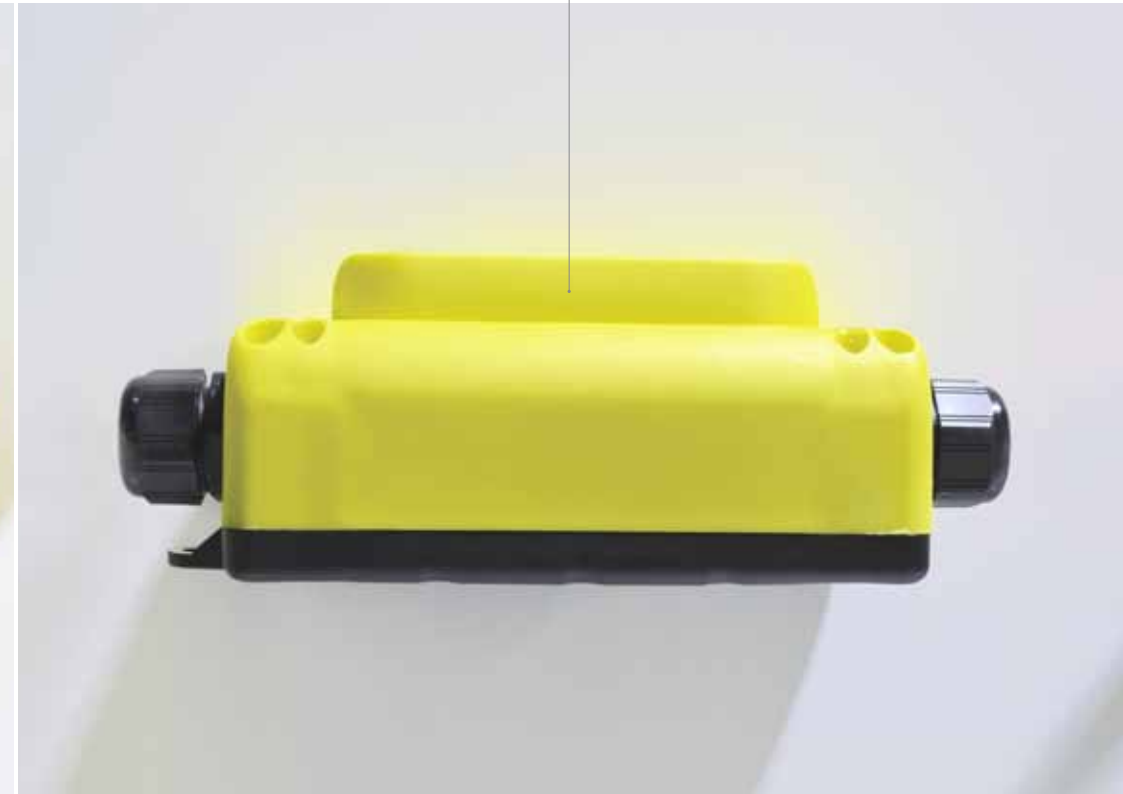

+ **CABLE STRAIN RELIEF**

stable and secure strain relief avoids unwanted breaking of the copper core in the cable

+ **CARABINER**

Thanks to the suspension lug, the switch box can be easily and quickly fastened with the supplied carabiner hook and steel wire rope





# MEASUREMENT . ALDEBARAN® XLD-2 / XLD-2C AT A SUSPENSION HEIGHT OF 4m

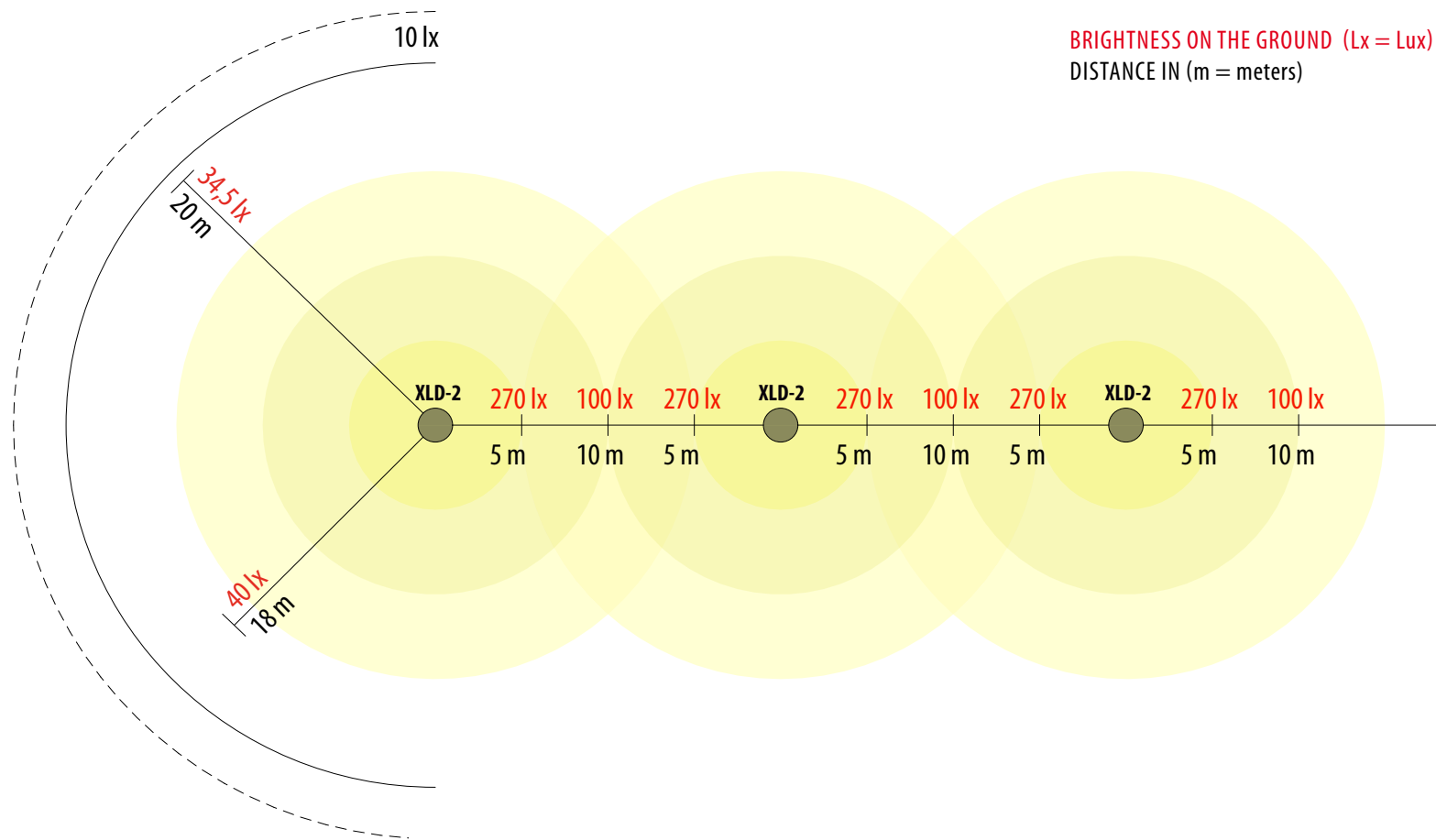

**ALDEBARAN® XLD-1C  
BUDGET-FRIENDLY  
LIGHTING TOOL**





## ALDEBARAN® XLD-1C PRODUCT CHARACTERISTICS

- ✔ IP67, dust- and water-proof
- ✔ Unbeatable price-performance ratio
- ✔ Light power with 45.000 REAL Lumen
- ✔ 4 x SETO Xpect2 LED module
- ✔ Slip-on filters for homogeneous illumination in close range

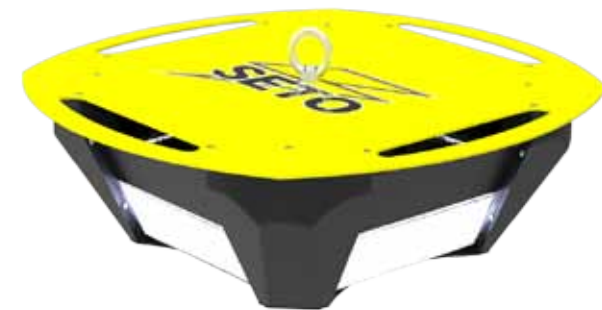



**BOTH VARIANTS OF THE  
ALDEBARAN® XLD-C SERIES  
IN COMPARISON**

**ALDEBARAN®  
XLD-2C**

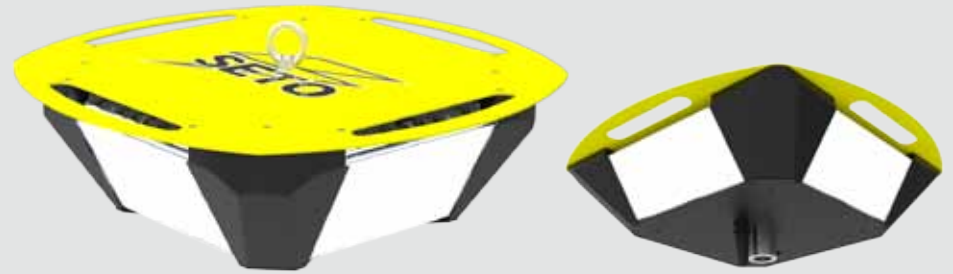

**ALDEBARAN®  
XLD-1C**

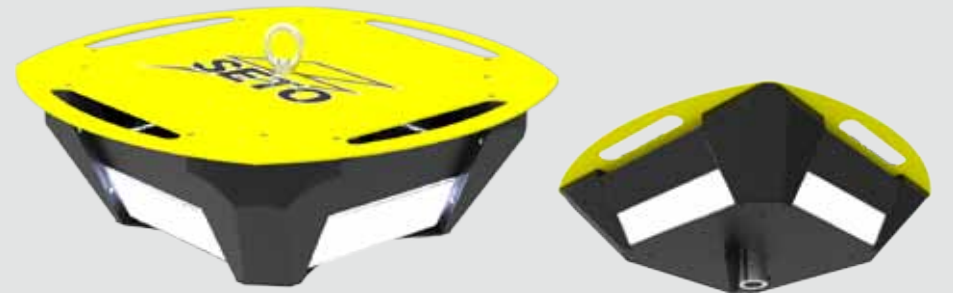

## ALDEBARAN® XLD-2C

Equipped with 8 SETO Xpect LED modules including slip-on filters, this all-round light output of 90,000 REAL lumens. The **ALDEBARAN® XLD-2C** is available in several models with various connected loads and functions.

### INCLUDED IN THE DELIVERY:

Diffusers | Bolt reception | Suspension | Transport box



## ALDEBARAN® XLD-1C

is the budget-friendly alternative, also with IP67. Despite the unbeatable price-performance ratio, the **ALDEBARAN® XLD-1C** has an excellent light output of up to 45,000 REAL lumen. The 4 SETO Xpect LED modules ensure a concentrated and homogenous working light.

### INCLUDED IN THE DELIVERY:

Diffusers | Bolt reception | Suspension | Transport box



RCK:  
REPLACEABLE CABLE-SET

Item no: 1410001502

**ALDEBARAN® XLD-2C BASIC (SUPPLY LINE)**



**Supply line with**  
plug IP68, PUR cable H07BQ-F 3G1,5 (8 m), connector

Item no.: 1410001503

**ALDEBARAN® XLD-2C SWITCH (SUPPLY LINE + SWITCH BOX)**



SEGMENTAL SWITCHING

**Supply line with**  
plug IP68, PUR cable H07BQ-F 3G1,5 (5 m)  
Ölflex® 540P (3 m), connector  
Steel rope with snap hook

**Switch box (IP65) with pressure switch „On/Off“**

Item no.: 1410001504

**ALDEBARAN® XLD-2C DIM (SUPPLY LINE + SWITCH BOX + DIMMING FUNCTION)**



SEGMENTAL SWITCHING

**Supply line with**  
plug IP68, PUR cable H07BQ-F 3G1,5 (5 m)  
Ölflex® 540P (3 m), connector  
Steel rope with anap hook

**Switch box (IP65) with pressure switch „On/Off“, integrated dimming function**

### TECHNICAL DATA

Input voltage 100-240 VAC, 50/60 Hz  
Power consumption 560 W

Illuminant 8 x Xpect2 LED module  
Luminous flux (REAL Lumen)\* 90.000 lm  
Colour temperature 5000 K  
CRI >70  
Life time 50.000 hrs

Ambient temperature -40 °C to +59 °C  
Dimension (LxWxH) 291 x 650 x 650 mm  
Weight 17,6 kg  
IP code IP67\*

\* Models without switch box

Item no.: 1410001501

**ALDEBARAN® XLD-1C BASIC (SUPPLY LINE)**



**Supply line with**  
plug IP68, PUR cable H07BQ-F 3G1,5 (8 m), connector

### TECHNICAL DATA

Input voltage 100-240 VAC, 50/60 Hz  
Power consumption 280 W

Illuminant 4 x Xpect2 LED module  
Luminous flux (REAL Lumen)\* 45.000 lm  
Colour temperature 5000 K  
CRI >70  
Life time 50.000 hrs

Ambient temperature -40 °C to +59 °C  
Dimension (LxWxH) 291 x 650 x 650 mm  
Weight 13,5 kg  
IP code IP67



\* The max. lumen measuring values indicated at products with the quality seal REAL Lumen (RL) are generally really achieved values concerning the complete product incl. reflector, spreading lens etc. and correspond not only to the theoretical max. values of the used illuminant. For this purpose, we measure accordingly marked products in our own light laboratory under real operating conditions ourselves.

# THE INNER LIFE OF THE ALDEBARAN® XLD SERIES

Video / IP67



[y2u.be/Icj6HSDX0A4](https://www.youtube.com/watch?v=Icj6HSDX0A4)

- + **WATER-PROOF IP67**  
optimal protection against the entering of foreign matters, the entire electronics are installed according to **IP67** (dust and water-proof)
- + **REPAIRABLE**  
all components are replaceable

Video / IK10



[y2u.be/-xWbyUup1N4](https://www.youtube.com/watch?v=xWbyUup1N4)

- + **NYLON HOUSING PA 6.6**  
the light material protects against moisture, dust and dirt, and withstands extreme temperatures
- + **SHOCK RESISTANCE IK10**

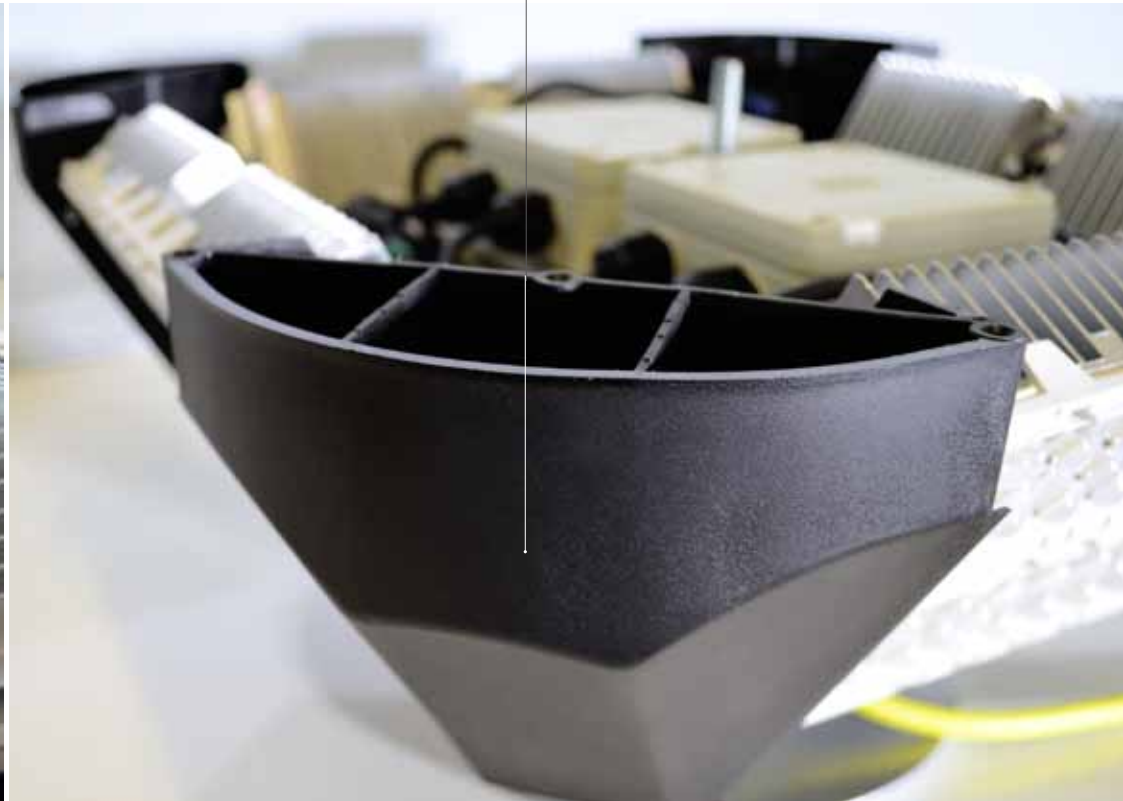
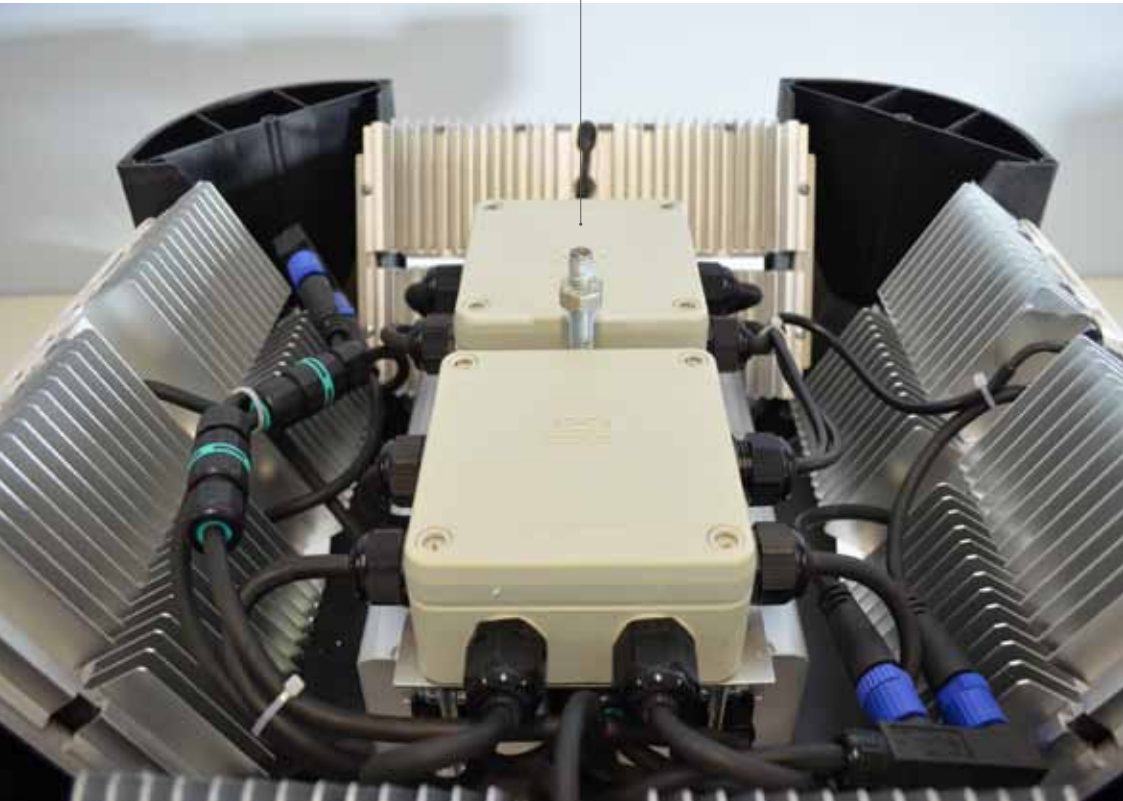



# OPTIONAL INSTALLATION FOR USE ON BUILDING SITES

- + **MOBILE DEVICE FROM ROBUST ALUMINIUM**  
for the safe installation of lighting systems in the construction site area.  
This robust system is easy to handle and can be transported quickly



- + **FOOTPLATE CARRIER**  
offers highest stability

- + **INTEGRATED PROTECTION BRACKETS**  
for optimal securing of the non-slip foot plates



# Professional Li

# ighting Solutions



[setolite.com/de](https://setolite.com/de)

**SETOLITE** Lichttechnik GmbH  
Bockhackerstr. 13  
42499 Hückeswagen  
Germany

Tel.: +49 (0) 21 92 - 9 36 24-0  
Fax.: +49 (0) 21 92 - 9 36 24-25

E-mail: [info@setolite.com](mailto:info@setolite.com)  
Internet: [www.setolite.com](http://www.setolite.com)



[facebook.com/setolite](https://facebook.com/setolite)



07.2017 Rev. 01.1  
Technical changes and errors reserved.